

COTEK

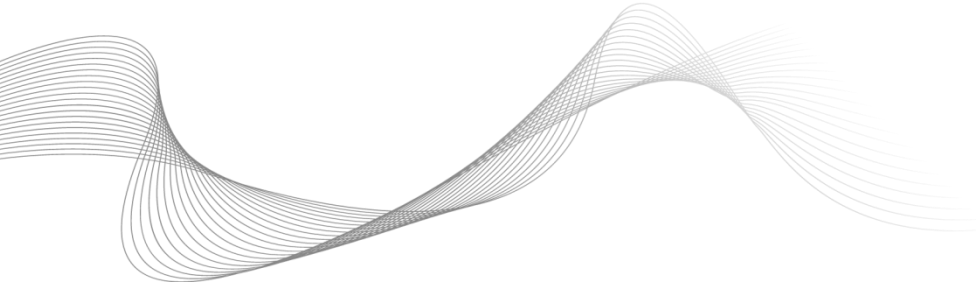

SE Series I g Y f Đ g ' ,

200W / 350W / 400W

PURE SINE WAVE INVERTER

Legal Provisions

Copyrights 2017 COTEK Electronic IND. CO. All Rights Reserved.

Any part of this document may not be reproduced in any form for any purpose without the prior written permission of COTEK Electronic IND. CO. For the conditions of the permission to use this manual for publication, contact COTEK Electronic IND. CO., LTD. In all related COTEK product activities, Neither COTEK Electronic IND. CO., LTD. nor its distributors or dealers be liable to anyone for indirect, incidental, or consequential damages under any circumstances. Specifications are subject to change without notice. Every attempt has been made to make this document complete, accurate and up-to-date. COTEK Electronic IND. CO., LTD reserve the right to make changes without notice and shall not be responsible for any damages, including indirect, incidental or consequential damages, caused by reliance on the material presented, including, but not limited to, omissions, typographical errors, arithmetical errors or listing errors in the content material. All trademarks are recognized even if these are not marked separately. Missing designations do not mean that a product or brand is not a registered trademark.

Table of Content

1. SAFETY INSTRUCTIONS	1
1-1. General Safety Precautions	1
1-2. Other Safety Notes	2
2. FUNCTIONAL CHARACTERISTICS INTRODUCTION	3
2-1. System	3
2-2. Block Diagram	3
2-3. Electrical Specification	4
2-3-1. SE200 Specification	4
2-3-2. SE350 Specification	5
2-3-3. SE400 Specification	7
2-4. Mechanical Drawings	10
3. INSTALLATION AND MAINTENANCE	11
3-1. Front Panel Introduction	11
3-1-1. ON / OFF / Remote Main Switch	11
3-1-2. LED Indicator	11
3-1-3. AC Output	13
3-1-4. Function Switch	14
3-2. Rear Panel Introduction	15
3-2-1. DC Input Terminal	15
3-2-2. Green Terminal	16
3-2-3. Remote Port (RJ-11)	17
3-2-4. Chassis ground	18
3-3. Maintenance	18
3-4. Inverter Installation and Operation	18

4. OPERATION	20
4-1. Connecting the DC Cable	20
4-2. Connecting the Input Power	20
4-3. Connecting the Loads	20
4-4. Switch ON Inverter	21
4-5. Protection Mechanism	21
4-5-1. SE200 Protection Mechanism	21
4-5-2. SE350 protection mechanism	21
4-5-3. SE400 Protection Mechanism	22
4-6. Troubleshooting Guide	22
5. WARRANTY	24
5-1 Warning	24
5-2 Warranty	24

1. Safety Instructions

1-1. General Safety Precautions



Warning! Before using the Inverter, read the safety instructions.

- ' Do not expose the inverter to rain, snow, spray or dust. To reduce the risk of fire hazard, do not cover or obstruct the ventilation openings and do not install the inverter in a zero-clearance compartment.
- ' To avoid the risk of fire and electric shock, make sure that the existing wiring is in good electrical condition, and the wire size is not undersized.
- ' This equipment contains components which can produce arcs or sparks. To prevent fire or explosion do not install in compartment containing batteries or flammable materials or in location which require ignition protected equipment. This includes any space containing gasoline-powered machinery, fuel tanks, or joints, fittings, or other connection between components of the fuel system.
- ' Depending on the user scenario, the AC output of the inverter may require user installed breaker or fuse. In AC output hardwire application, AC socket will not be provided. The inverter incorporates standard AC short circuit protection.
- ' An over current protection at the time of installation shall be provided by others for the AC output circuit.
- ' Additional breakers suitable for 20A(SE200 & SE350) / 10A(SE400) branch circuit protection shall be provided for the GFCI receptacles.
- ' The following precautions should be taken when working on the inverter:
 - Step 1 Remove watches, rings, or other metal objects
 - Step 2 Use tools with insulated handles
 - Step 3 Wear rubber gloves and boots

1-2. Other Safety Notes

- ' Upon receipt, examine the carton box for damage. If you have found any damage on the carton box please notify the company you purchased this unit from.
- ' Do not operate near water or in excessive humidity.
- ' Do not open or disassemble the inverter, and warranty may be voided.
- ' The DC side connections should be firm and tight.
- ' Grounding: Reliable grounding should be maintained.
- ' Do not drop a metal tool on the battery. The resulting spark or short-circuit on the battery or on the other electrical part may cause an explosion.
- ' Install the inverter in a well-ventilated area. Do not block the air vents at the front AC output side, or the air exhausts at the rear DC input side.
- ' Wiring: Adequate input power must be supplied to the inverter for proper use; correct wiring sizes must be ensured.
- ' Mount the inverter such that the fan axis is horizontal.
- ' Do not operate the inverter close to combustible gas or open fire.
- ' Do not operate appliances that may feed power back into the inverter.
- ' The inverter should be operated in an ambient temperature range -20 to 60 .

Otherwise the output efficiency may be affected. Air flow to the inverter must not be blocked.

2. Functional Characteristics Introduction

2-1. System

The unit is a highly reliable DC-AC inverter system, designed with advanced power electronic and microprocessor technology offering the following features:

- ' Pure sine wave output waveform
SE200 THD < 3 % / SE350 THD < 3 % / SE400 THD < 5 %
- ' Intelligent software for power management
- ' Loading and temperature controlled cooling fan
- ' CR-8 remote management and control
- ' Dry contact terminal
- ' Advanced protection features

Input protection

- Ø Over/Under voltage protection
- Ø Reverse polarity protection (Fuse)

Output protection

- Ø Overload protection
- Ø Over temperature protection
- Ø Short circuit protection

2-2. Block Diagram

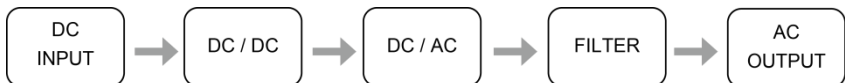

2-3. Electrical Specification

2-3-1. SE200 Specification

Electrical	Specification	Model No.			
	Item	SE200-112	SE200-124	SE200-212	SE200-224
Input	Voltage	12VDC	24VDC	12VDC	24VDC
	Voltage Range	10.0~16.0VDC	20.0~32.0VDC	10.0~16.0VDC	20.0~32.0VDC
	No Load Current	< 0.5A	< 0.4A	< 0.5A	< 0.4A
	Power Saving Mode	< 0.12A	< 0.06A	< 0.12A	< 0.06A
	Efficiency (Typ.)	89%	91%	91%	93%
	On Mode @ Save Mode	< 0.12A	< 0.06A	< 0.12A	< 0.06A
On Mode @ No Load Mode	< 0.5A	< 0.4A	< 0.5A	< 0.4A	
Output	Continuous Output Power	200 W			
	Over Rated Power (3 Min.)	230 W			
	Peak Power (3 Sec.)	250 W			
	Frequency	50 / 60 Hz ± 0.5% (Dip Switch Selectable)			
	Output Voltage	100 / 110 / 115 / 120 VAC ± 5% (Dip Switch Selectable)		200 / 220 / 230 / 240 VAC ± 5% (Dip Switch Selectable)	
	Short-Circuit Protection	2 seconds and restart 3 times shutdown			
Output Waveform	Pure Sine Wave (THD < 3%@ Normal Load)				
Protection	Input Over-Voltage Protection	16.0VDC ± 3%	32.0VDC ± 3%	16.0VDC ± 3%	32.0VDC ± 3%
	Input Under-Voltage Protection	10.0VDC ± 3%	20.0VDC ± 3%	10.0VDC ± 3%	20.0VDC ± 3%
	BAT. Low Shutdown	10.0VDC ± 3%	20.0VDC ± 3%	10.0VDC ± 3%	20.0VDC ± 3%
	BAT. Low Alarm	10.5VDC ± 3%	21.0VDC ± 3%	10.5VDC ± 3%	21.0VDC ± 3%
	BAT. Low Restart	12.5VDC ± 3%	25.0VDC ± 3%	12.5VDC ± 3%	25.0VDC ± 3%
	BAT. High Alarm	15.5VDC ± 3%	31.0VDC ± 3%	15.5VDC ± 3%	31.0VDC ± 3%
	BAT. High Shutdown	16.0VDC ± 3%	32.0VDC ± 3%	16.0VDC ± 3%	32.0VDC ± 3%
BAT. High Restart	14.5VDC ± 3%	29.0VDC ± 3%	14.5VDC ± 3%	29.0VDC ± 3%	
Environment	Working Temp.	-20 ~60			
	Storage Temp.	-30 ~70			
	Working Humidity	10~95% RH, non-condensing			
Safety & EMC	Safety Standards	----		Certified EN 60950-1	
	EMC standards	Certified FCC class B		Certified EN55022; EN61204-3 EN61000-6-1, 6-3 EN61000-3-2, -3-3; EN55024 EN61000-4-2, 3, 4, 5, 6, 8, 11	
	E-mark	----		Certified CISPR 25; ISO 7637-2	
Others	Dimension(WxHxD)	150 mm X 68mm X187 mm			
	Weight	1.6kg			
	Remote Control	CR-8 (optional)			
	Cooling	Temperature & Load Controlled cooling Fan			

Table 1. SE200 specification



Note

This test condition is normal DC input and temperature 25

2-3-2. SE350 Specification

Electrical	Specification	Model No.		
	Item	SE350-112	SE350-124	SE350-148
Input	Voltage	12VDC	24VDC	48VDC
	Voltage Range	10.0~15.5VDC	20.0~31.0VDC	40.0~62.0VDC
	No Load Current	< 0.65A	< 0.32A	< 0.16A
	Power Saving Mode	< 90mA	< 60mA	< 40mA
	Efficiency (Typ.)	87%	88%	89%
	On Mode @ Save Mode	< 90mA	< 60mA	< 40mA
	On Mode @ No Load Mode	< 0.65A	< 0.32A	< 0.16A
Output	Continuous Output Power	350 W		
	Surge Power	700 W		
	Frequency	50 / 60 Hz ± 0.1% (Dip Switch Selectable)		
	Output Voltage	100 / 110 / 115 / 120 VAC ± 5% (Dip Switch Selectable)		
	Short-Circuit Protection	2 seconds and restart 4 times shutdown		
	Output Waveform	Pure Sine Wave (THD < 3%@ Normal Load)		
Protection	Input Over-Voltage Protection	15.5V 0.25V	31.0V 0.5V	62.0V 1V
	Input Under-Voltage Protection	10.0V 0.25V	20.0V 0.5V	40.0V 1V
	BAT. Low Shutdown	10.0V 0.25V	20.0V 0.5V	40.0V 1V
	BAT. Low Alarm	10.5V 0.25V	21.0V 0.5V	42.0V 1V
	BAT. Low Restart	12.0V 0.25V	24.0V 0.5V	48.0V 1V
	BAT. High Alarm	15.0V 0.25V	30.0V 0.5V	60.0V 1V
	BAT. High Shutdown	15.5V 0.25V	31.0V 0.5V	62.0V 1V
	BAT. High Restart	14.5V 0.25V	29.0V 0.5V	58.0V 1V
Environment	Working Temp. ^{Note}	-20 ~60		
	Storage Temp.	-30 ~70		
	Working Humidity	90% RH, non-condensing		
Safety & EMC	Safety Standards	----		
	EMC standards	----		
	E-mark	----		
Others	Dimension(WxHxD)	150 mm X 68mm X187 mm		
	Weight	1.6kg		
	Remote Control	CR-8 (optional)		
	Cooling	Temperature & Load Controlled cooling Fan		

Table 2. SE350 for output 100/110/115/120 VAC specification



Note

Temperature performance Please refer to Figure 1

Electrical	Specification	Model No.		
	Item	SE350-212	SE350-224	SE350-248
Input	Voltage	12VDC	24VDC	48VDC
	Voltage Range	10.0~15.5VDC	20.0~31.0VDC	40.0~62.0VDC
	No Load Current	< 0.9A	< 0.5A	< 0.25A
	Power Saving Mode	< 90mA	< 60mA	< 40mA
	Efficiency (Typ.)	89%	90%	91%
	On Mode @ Save Mode	< 90mA	< 60mA	< 40mA
	On Mode @ No Load Mode	< 0.9A	< 0.5A	< 0.25A
Output	Continuous Output Power	350 W		
	Surge Power	700 W		
	Frequency	50 / 60 Hz \pm 0.1% (Dip Switch Selectable)		
	Output Voltage	200 / 220 / 230 / 240 VAC \pm 5% (Dip Switch Selectable)		
	Short-Circuit Protection	2 seconds and restart 4 times shutdown		
	Output Waveform	Pure Sine Wave (THD < 3% @ Normal Load)		
Protection	Input Over-Voltage Protection	15.5V 0.25V	31.0V 0.5V	62.0V 1V
	Input Under-Voltage Protection	10.0V 0.25V	20.0V 0.5V	40.0V 1V
	BAT. Low Shutdown	10.0V 0.25V	20.0V 0.5V	40.0V 1V
	BAT. Low Alarm	10.5V 0.25V	21.0V 0.5V	42.0V 1V
	BAT. Low Restart	12.0V 0.25V	24.0V 0.5V	48.0V 1V
	BAT. High Alarm	15.0V 0.25V	30.0V 0.5V	60.0V 1V
	BAT. High Shutdown	15.5V 0.25V	31.0V 0.5V	62.0V 1V
	BAT. High Restart	14.5V 0.25V	29.0V 0.5V	58.0V 1V
Environment	Working Temp. ^{Note}	-20 ~60		
	Storage Temp.	-30 ~70		
	Working Humidity	90% RH, non-condensing		
Safety & EMC	Safety Standards	Certified EN 60950-1		
	EMC standards	Certified EN55022 class B, EN 55024; EN61204-3 EN61000-3-2, -3-3; EN 61000-6-1, -6-3 IEC 61000-4-2, 3, 4, 5, 6, 8, 11		
	E-mark	Certified CISPR 25; ISO 7637-2		
Others	Dimension(WxHxD)	150 mm X 68mm X187 mm		
	Weight	1.6kg		
	Remote Control	CR-8 (optional)		
	Cooling	Temperature & Load Controlled cooling Fan		

Table 3. SE350 for output 200/220/230/240 VAC specification



Note

Temperature performance Please refer to Figure 1

2-3-3. SE400 Specification

Electrical	Specification	Model No.		
	Item	SE400-112	SE400-124	SE400-148
Input	Voltage	12VDC	24VDC	48VDC
	Voltage Range	10.5~16.0VDC	21.0~32.0VDC	42.0~64.0VDC
	No Load Current	<1A @12VDC	<0.5A @24VDC	<0.25A @48VDC
	Power Saving Mode	<0.2A @12VDC	<0.1A @24VDC	<0.05A @48VDC
	Efficiency (Typ.)	88%	89%	90%
	On Mode @ Save Mode	<1A @12VDC	<0.5A @24VDC	<0.25A @48VDC
	On Mode @ No Load Mode	<0.2A @12VDC	<0.1A @24VDC	<0.05A @48VDC
Output	Continuous Output Power	400 W (± 3%)		
	Max. Output Power (1Min.)	> 400 W~460 W (100%~115%)		
	Surge Power (1Sec.)	< 800 W		
	Frequency	50 / 60 Hz ± 0.5% (Dip Switch Selectable)		
	Output Voltage	100 / 110 / 115 / 120 VAC ± 5% (Dip Switch Selectable)		
	Short-Circuit Protection	1 Sec Shutdown		
	Output Waveform ^	Pure Sine Wave (THD < 5%@ Normal Load)		
Protection	Input Over-Voltage Protection _	16.0 ± 0.3VDC	32.0 ± 0.5VDC	64.0 ± 1.0VDC
	Input Under-Voltage Protection	10.5 ± 0.3VDC	21.0 ± 0.5VDC	42.0 ± 1.0VDC
	BAT. Low Shutdown	10.5 ± 0.3VDC	21.0 ± 0.5VDC	42.0 ± 1.0VDC
	BAT. Low Alarm	10.5 ± 0.3VDC	21.0 ± 0.5VDC	42.0 ± 1.0VDC
	BAT. Low Restart	14.5V± 0.3V	28.0 ± 0.5VDC	56.0 ± 0.5VDC
	BAT. High Shutdown	16.0 ± 0.3VDC	32.0 ± 0.3VDC	64.0 ± 0.3VDC
	BAT. High Restart	12.5V± 0.3V	25.0V± 0.3V	50.0± 0.3V
Environment	Working Temp. `	-20 ~-40		
	Storage Temp.	-30 ~-70		
	Working Humidity	10~95% RH, non-condensing		
Safety & EMC	Safety Standards	Certified UL 458 (UL only for GFCI receptacles)		----
	EMC standards	Certified FCC class B		
	E-mark	----		
Others	Dimension(WxHxD)	150 mm X 68mm X187 mm		
	Weight	1.256kg		
	Remote Control	CR-8 (optional)		
	Cooling	Temperature & Load Controlled cooling Fan		

Table 4. SE400 for output 100/110/115/120 VAC specification



Note

^ Normal load Condition Vin =12.5V/25V/50V, Vo=100/110/115/120 VAC 80% load (PF=1.0)

_ Voltage performance Please refer to Figure 2

` Temperature performance Please refer to Figure 3

Electrical	Specification	Model No.		
	Item	SE400-212	SE400-224	SE400-248
Input	Voltage	12VDC	24VDC	48VDC
	Voltage Range	10.5~16.0VDC	21.0~32.0VDC	42.0~64.0VDC
	No Load Current	<1A @12VDC	<0.5A @24VDC	<0.25A @48VDC
	Power Saving Mode	<0.2A @12VDC	<0.1A @24VDC	<0.05A @48VDC
	Efficiency (Typ.)	88%	89%	90%
	On Mode @ Save Mode	<1A @12VDC	<0.5A @24VDC	<0.25A @48VDC
	On Mode @ No Load Mode	<0.2A @12VDC	<0.1A @24VDC	<0.05A @48VDC
Output	Continuous Output Power	400 W (± 3%)		
	Max. Output Power (1Min.)	> 400 W~460 W (100%~115%)		
	Surge Power (1Sec.)	< 800 W		
	Frequency	50 / 60 Hz ± 0.5% (Dip Switch Selectable)		
	Output Voltage	200 / 220 / 230 / 240 VAC ± 5% (Dip Switch Selectable)		
	Short-Circuit Protection	1 Sec Shutdown		
	Output Waveform ^	Pure Sine Wave (THD < 5%@ Normal Load)		
Protection	Input Over-Voltage Protection _	16.0 ± 0.3VDC	32.0 ± 0.5VDC	64.0 ± 1.0VDC
	Input Under-Voltage Protection	10.5 ± 0.3VDC	21.0 ± 0.5VDC	42.0 ± 1.0VDC
	BAT. Low Shutdown	10.5 ± 0.3VDC	21.0 ± 0.5VDC	42.0 ± 1.0VDC
	BAT. Low Alarm	10.5 ± 0.3VDC	21.0 ± 0.5VDC	42.0 ± 1.0VDC
	BAT. Low Restart	14.5V± 0.3V	28.0 ± 0.5VDC	56.0 ± 0.5VDC
	BAT. High Shutdown	16.0 ± 0.3VDC	32.0 ± 0.3VDC	64.0 ± 0.3VDC
	BAT. High Restart	12.5V± 0.3V	25.0V± 0.3V	50.0± 0.3V
Environment	Working Temp. `	-20 ~40		
	Storage Temp.	-30 ~70		
	Working Humidity	10~95% RH, non-condensing		
Safety & EMC	Safety Standards	Certified EN 62368-1		
	EMC standards	Certified EN55032 class B; EN 55024; EN 61000-3-2, -3-3 IEC61000-4-2, 3, 4, 5, 6, 8, 11		
	E-mark	Certified CISPR 25; ISO11452-2; ISO 7637-2		
Others	Dimension(WxHxD)	150 mm X 68mm X187 mm		
	Weight	1.256kg		
	Remote Control	CR-8 (optional)		
	Cooling	Temperature & Load Controlled cooling Fan		

Table 5. SE400 for output 200/220/230/240 VAC specification



Note

^ Normal load Condition Vin =12.5V/25V/50V, Vo=200/220/230/240 VAC 80% load (PF=1.0)

_ Voltage performance Please refer to Figure 2

` Temperature performance Please refer to Figure 3

2-3-4. SE350 Voltage performance

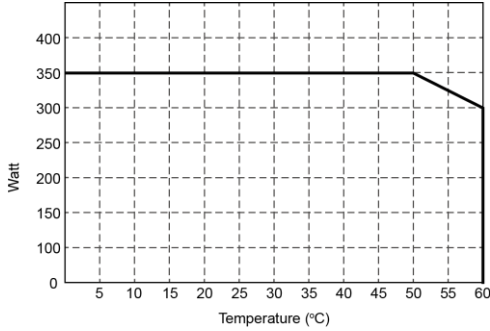

Figure 1. SE 350 temperature performance

2-3-5. SE400 Voltage & temperature performance

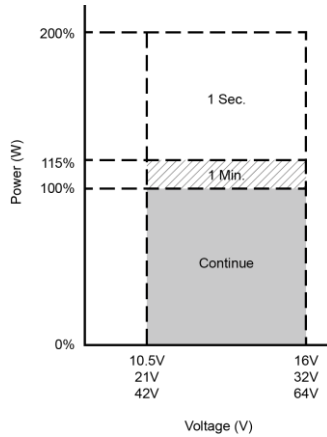

Figure 2. SE400 voltage performance

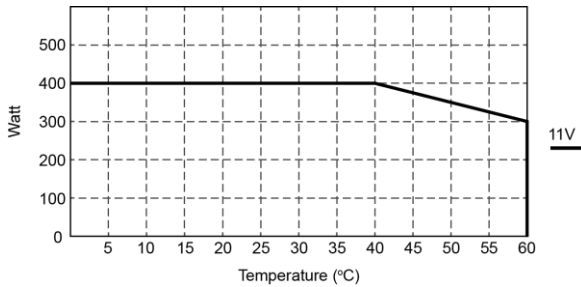

Figure 3. SE400 temperature performance

2-4. Mechanical Drawings

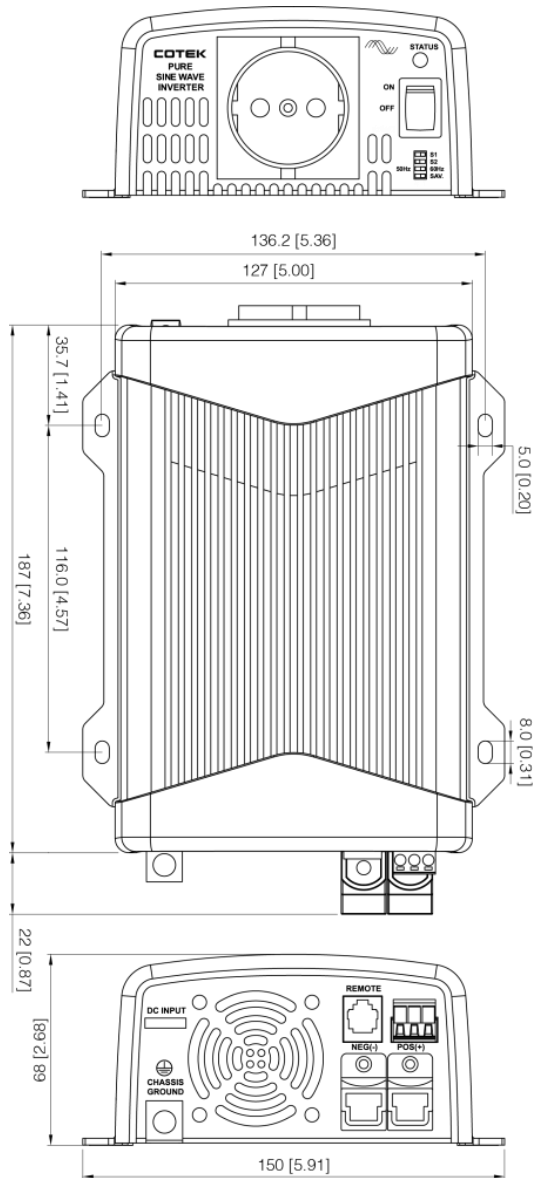

Figure 4. SE series mechanical drawings

3. Installation and Maintenance

3-1. Front Panel Introduction

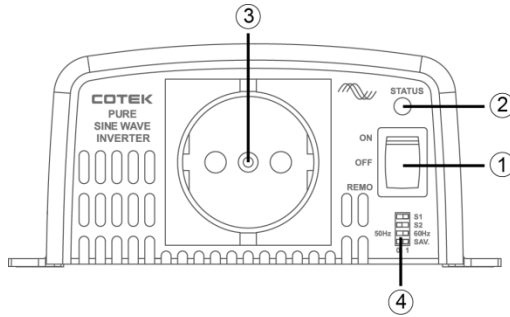

Figure 5. SE series front panel view

Model	SESeries Front Panel
^	ON / OFF / Remote Main Switch
_	LED Indicator
`	AC Output
a	Function Switch

Table 6. SE series front panel introduction

3-1-1. ON / OFF / Remote Main Switch ^

The 3-stage switch ^ is for turning on, turning off and remote mode.

3-1-2. LED Indicator _

Inverter status to display fault condition.

' SE200 / SE350 LED signal

Status	LED Signal	Description
Power on	R O G G R=red, O=orange, R=red	Beep twice, LED shows red à orange à green à green
Green		
Normal		LED lights in solid green
Saving mode		LED flashes green condition in intermediate condition once every 2 seconds

Status	LED Signal	Description
Orange		
Under voltage alarm	— — — — —	LED flashes orange light slowly with 5 short beeps every 15 seconds
Over voltage	-----	LED flashes orange light every 0.1 seconds
Red		
Over temperature	-- -- --	LED flashes red light quickly twice every 1.6 seconds
O/P short circuit	—————	LED lights red; following two short beeps. Inverter shuts down after two seconds and restart 3 times.
O/P over load	—————	LED lights red; following two short beeps. Inverter shuts down after 3 minutes and restart 3 times.
Shut down under voltage	— — — — —	LED flashes red light every 0.4 seconds, then inverter shuts down.
Shut down over voltage	-----	LED flashes red light every 0.1 seconds, then inverter shut down.
Fan alarm	— .. — .. — ..	LED flashes red light slowly once and quickly twice every 1.6 seconds

Table 7. SE200 & SE350 LED status

' SE400 LED signal

Status	LED Signal	Description
Green		
Normal or Power ON	—————	LED lights in solid green
Orange		
Over load	-----	LED fast blink with two long beeps
Over temp. / Under temp. (Heat sink temp. over 80 or under -20)	— — — — —	LED slow blink

Status	LED Signal	Description
Red		
Over current / Over load (AC output short-circuit and over load)	—————	LED lights in solid red with one short beeps
Over voltage (Input DC voltage over spec.)	- - - - -	LED fast blink
Under voltage (Input DC voltage under spec.)	- - - - -	LED slow blink with one long beeps & two short beeps

Table 8. SE400 LED status

3-1-3. AC Output







			
North America (GFCI)	NEMA 5-15R	Australia / New Zealand	Continental Europe
			
United Kingdom	Universal	France Connector (only SE350)	IEC (only SE350)

Table 9. SE series AC output

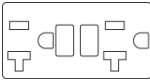
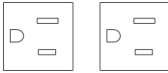
3-1-4. Function Switch a

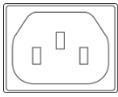
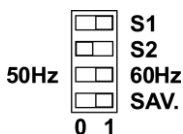

Figure 6. SE series DIP switch

3-1-4-1. Function switch definition

Dip Switch	Function
S1	Voltage select
S2	Voltage select
S3	Frequency Select
S4	Power saving ON/OFF

Table 10. SE series function switch definition

3-1-4-2. Output voltage selection (S1&S2)

Output voltage	S1	S2
100V/200V	0	0
110V/220V	0	1
115V/230V	1	0
120V/240V	1	1

Table 11. SE series output voltage selection



Note

100V series can be selected between 100/110/115/120VAC, and 200V series can be selected between 200/220/230/240VAC.

3-1-4-3. Output frequency selection

Frequency	DIP Switch
50Hz	0
60Hz	1

Table 12. SE series output frequency selection

3-1-4-4. Power saving selection

Saving function	DIP Switch
Power Saving OFF	0
Power Saving ON	1

Table 13. SE series power saving selection

3-1-3-5. Power saving load

Model	Input Saving Power	Saving Wake up
SE200 / SE350	<10VA	>15VA
SE400	<20A	>30 VA

Table 14. SE series power saving load

3-2. Rear Panel Introduction

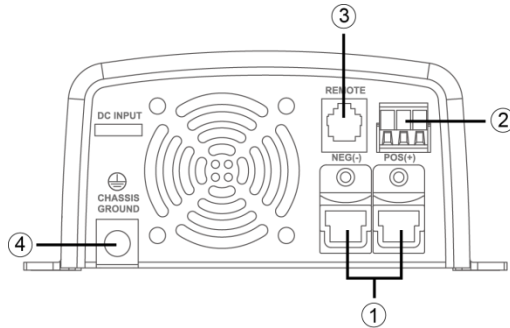

Figure 7. SE series rear panel view

Model	SE Series Rear Panel
^	DC Input Terminal
—	Green Terminal
~	Remote Port (RJ-11)
a	Chassis Ground

Table 15. SE series rear panel introduction

3-2-1. DC Input Terminal ^

The DC cables should be as short as possible (less than 6 feet / 1.8 meters ideally)

The size of the cable should be thick enough to limit the voltage drop to less than 2% when carrying the maximum input current to prevent frequent low-input voltage warnings, and shutdown.

The following sizes of cables and fuses are recommended distance (<6 ft.) between the batteries and the inverter.

Model	Wire AWG	Inline fuse
SE200-112 / 212	#10	30 A
SE200-124 / 224	#14	15 A
SE350-112 / 212	#8	50A

Model	Wire AWG	Inline fuse
SE350-124 / 224	#10	25 A
SE350-148 / 248	#14	12.5A
SE400-112 / 212	#10	60A
SE400-124 / 224	#14	30 A
SE400-148 / 248	#18	15 A

Table 16. SE series cable size



Note

Batteries are capable of providing very large currents in case of short circuit. The fuse should be as close to the positive battery terminal as possible. Use Bussmann ANN series fuses (will also require Fuse Block 4164) or equivalent.

3-2-2. Green Terminal _

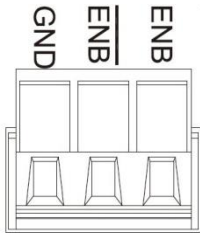

Item	Description
1	GND
2	Enable (ENB)
3	Enable (ENB)

Table 17. SE series green terminal description

Figure 8. SE series green terminal



Note

Fault conditions include Input under / over voltage, output short circuit / over load, over / under temperature.



Caution!

Please follow the following steps for the installation.

- ' Ó ^ ~ [| ^ Á ā } • c æ | | ā } * Á c @ ^ Á ā } ç ^ ! c ^ ! Ê Á { æ \ ^ Á position.
- ' Before using the remote function, make sure the main switch pressed c [, æ ! Ó ā T Á % Ü +
- ' Use 20 ~ 24 #AWG wire to connect the remote control terminals.

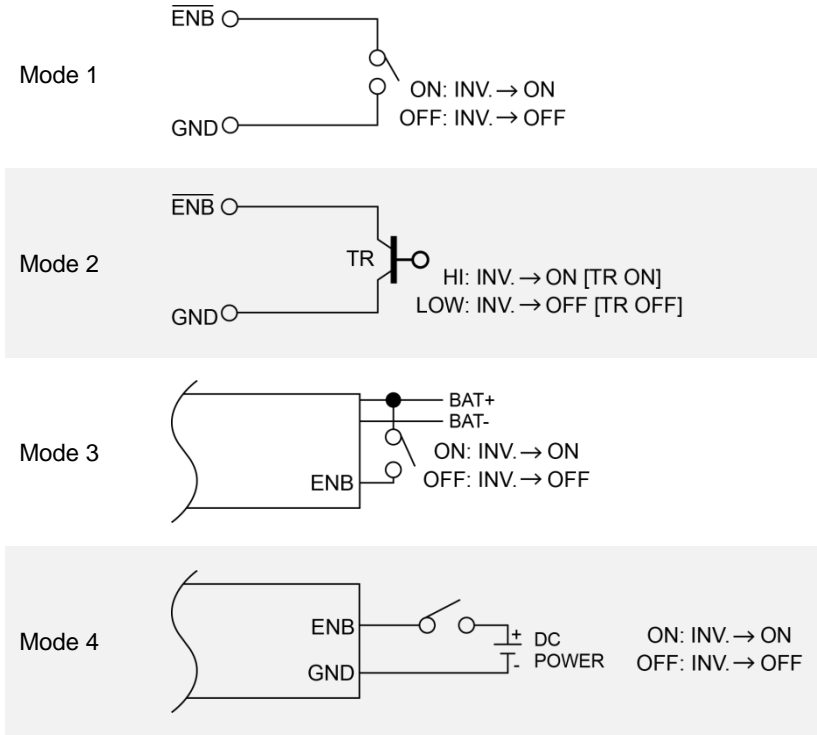

Table 18. SE series wiring for control

3-2-3. Remote Port (RJ-11)

The SE400 inverter can be compatible with CR-8 remote control.

Before using the remote control, make sure the main switch on

ã } ç ^ ! c ^ ! Á { ~ • c Á à ^ Á æ c Á %oÁ Ü Ò T U V Ò + Á] [• ã c

Pin Number	Signal Description	
1	Reserved	
2	GND	The same polarity as the battery negative side
3		
4		
5	RMT	Remote controller panel (positive)
6		

Table 19. SE series green terminal signal description

3-2-4. Chassis ground a

Must be connected to earth ground prior to making any other connections to the equipment.

3-3. Maintenance

Make sure that the fan vents are not blocked.

Use a vacuum cleaner to remove any dust from the fan area

When cleaning the case or front panel, use a soft, dry cloth, only. If the case or front panel is very dirty, use a neutral, non-abrasive detergent. Do not use alcohol or ammonia based solutions.

Regular service, and relocation of the inverter, should be performed by a qualified service technician. Avoid spilling liquid on the inverter.

3-4. Inverter Installation and Operation

Before installing the inverter, make sure the main switch must be %U Ø Ø + È

STEP 1.

Connect the DC cable, then connect the DC cable to battery.
(Make sure the polarity)



Figure 9. Installation step 1

STEP 2.

Dip switch setting for AC output voltage, frequency, and saving mode. (Refer to 3-1-4.)

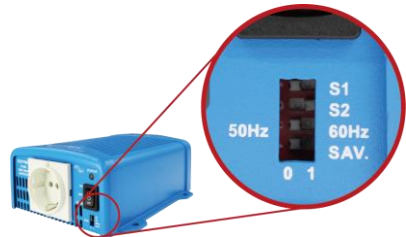

Figure 10. Installation step 2

STEP 3.

Connect the AC cable.



Figure 11. Installation step 3

STEP 4.

Power ON.

The buzzer will send
 [~ c Á %Ó ^ ^] + Á • [
 the moment the inverter
 will do self-diagnosis,
 then the power status
 LED indicators will also



Figure 12. Installation step 4

appear in ç æ! ã [~ • Á & [| [| • È Á Ø ã } æ| | ^ Á c @^ Á à ~ :
 and the power status LED indicators will turn to solid %Ö! ^ ^ } + Á & [| [
 (normal state), means the inverter is now ready to work.



Note:

1. If there is several loads used, turn them on separately after the
 ã } ç ^ | c ^ | Á @æ• Á à ^ ^ } Á %U P + Á ã } Á [| á ^ | Á c
 caused by the surge power.
2. Set power inverter switch to the ON position and turn the test
 load on. The inverter should supply power to the load. If you plan
 to accurately measure the true output r.m.s. voltage of inverter, a
 meter such as FLUKE 45 BECKMAN 4410 or TRIPLETT 4200
 must be used.

4. Operation

4-1. Connecting the DC Cable

Connect DC input terminals to 12V / 24V / 48V battery or other DC power source [+] is positive, [-] is negative. Reverse polarity connection can blow the internal fuse and may damage the inverter permanently.



Figure 13. DC cable connection



Warning! Make sure that all the DC connections are tight (torque to 9 . 10 ft-lbs, 11.7 . 13 Nm). Loose connections could result in overheating and can be a potential hazard.



Warning! The recommended inline fuse should be installed as close to the battery positive terminal as possible. An inline fuse between the inverter and battery may cause damage to the cable / inverter and will void warranty.

Also, only use high quality copper wire and keep the cable length short which is a maximum of 3 - 6 feet.

4-2. Connecting the Input Power

Before making the DC input side connections, the main switch must be turned off.

4-3. Connecting the Loads

Calculate the total power consumption of the output load. Make sure that the total power consumption does not exceed the rated power.

If the total power consumption over the rated power of the inverter, remove the non-critical: loads until the total power consumption is below the rated power.

4-4. Switch ON Inverter

When the inverter is powered on, all the lights that are on will go off.

4-5. Protection Mechanism

4-5-1. SE200 Protection Mechanism

Model	Over Voltage (DC)		Under Voltage Alarm	Under Voltage	
	Shutdown	Restart		Shutdown	Restart
12V	16V ± 3%	14.5V ± 3%	10.5V ± 3%	10.0V ± 3%	12.5V ± 3%
24V	32V ± 3%	29V ± 3%	21V ± 3%	20V ± 3%	25V ± 3%

Table 20. SE200 DC input protection mechanism

Model	Over Temperature Protection	
	Shutdown	Restart
12V	90 3	50 3
24V		

Table 21. SE200 over temperature protection mechanism

4-5-2. SE350 protection mechanism

Model	Over Voltage (DC)		Under Voltage Alarm	Under Voltage	
	Shutdown	Restart		Shutdown	Restart
12V	15.5V ± 0.25V	14.5V ± 0.25V	10.5V ± 0.25V	10V ± 0.25V	12V ± 0.25V
24V	31V ± 0.5V	29V ± 0.5V	21V ± 0.5V	20V ± 0.5V	24V ± 0.5V
48V	62 ± 1V	58V ± 1V	42V ± 1V	40V ± 1V	48 ± 1V

Table 22. SE350 DC input protection mechanism

Model	Over Temperature Protection	
	Shutdown	Restart
12V	83 5	53 5
24V		
48V		

Table 23. SE350 over temperature protection mechanism

4-5-3. SE400 Protection Mechanism

Model	Over Voltage (DC)		Under Voltage Alarm	Under Voltage	
	Shutdown	Restart		Shutdown	Restart
12V	16V ± 0.3V	14.5V± 0.3V	10.5V ± 0.3V	10.5V ± 0.3V	12.5V± 0.3V
24V	32V ± 0.5V	29V ± 0.5V	21V± 0.5V	21V ± 0.5V	25V ± 0.5V
48V	64 ± 1V	58V ± 1V	42V± 1V	42V ± 1V	50 ± 1V

Table 24. SE400 DC input p rotection mechanism

Model	Over Temperature Protection	
	Shutdown	Restart
12V	80	60
24V		
48V		

Table 25. SE400 over temperature p rotection mechanism

4-6. Troubleshooting Guide



Warning! Do not open or disassemble the inverter.

Attempting to service the unit yourself may result in a risk of electrical shock or fire.

SE200 / SE350 troubleshooting guide

LED Signal	Description	Solutions
<p>— — — — —</p> <p>LED flashes orange light slowly with 5 short beeps every 15 seconds</p>	Under voltage alarm	<ol style="list-style-type: none"> 1. Check connections and cable. 2. Recharge battery.
<p>—————</p> <p>LED flashes orange light every 0.1 seconds</p>	Over voltage	Check input voltage. Reduce input voltage to meet SE200 / SE350.
<p>—————</p> <p>LED lights red; following two short beeps. Inverter shuts down after 3 minutes and restart 3 times</p>	O/P over load	Reduce load. In case of restart failed, please turn on the unit manually.
<p>—————</p> <p>LED lights red; following two short beeps. Inverter shuts down after two seconds and restart 3 times</p>	O/P short circuit	Check AC wiring, make sure no circuit. In case of restart failed, please turn on the unit manually.

LED Signal	Description	Solutions
<p>-- -- --</p> <p>LED flashes red light quickly twice every 1.6 seconds</p>	Over temperature	Improve ventilation. Make sure ventilation openings in inverter are not obstructed. Reduce ambient temperature.
<p>-----</p> <p>LED flashes red light every 0.4 seconds, then inverter shuts down</p>	Shut down under voltage	Recharge battery. Check connections and cable. Please turn on the unit manually.
<p>-----</p> <p>LED flashes red light every 0.1 seconds, then inverter shut down</p>	Shut down over voltage	Check input voltage. Reduce input voltage. Please turn on the unit manually.
<p>— — — — —</p> <p>LED flashes red light slowly once and quickly twice every 1.6 seconds</p>	Fan alarm	1. Check fan connection wire 2. Clean the dust on the fan

Table 26. SE200 / SE350 t roublesleshooting guide

SE400 troubleshooting guide

LED Signal	Description	Solutions
<p>-----</p> <p>LED fast blink orange light with two long beeps</p>	Over load	Reduce load. In case of restart failed, please turn on the unit manually.
<p>— — — — —</p> <p>LED slow blink orange light</p>	Over temperature Under temperature	Improve ventilation. Make sure ventilation openings in inverter are not obstructed. Reduce ambient temperature.
<p>—————</p> <p>LED lights in solid red with one short beeps</p>	Over current Over load	Reduce load. In case of restart failed, please turn on the unit manually.
<p>-----</p> <p>LED fast blink red light</p>	Over voltage	Check input voltage. Reduce input voltage to meet SE400
<p>— — — — —</p> <p>LED slow blink red light with one long beeps &two short beeps</p>	Under voltage	Recharge battery. Check connections and cable. Please turn on the unit manually.

Table 27. SE 400 troubleshooting guide

5. Warranty

5-1 Warning



Warning!

Do not open or disassemble the Inverter. Attempting to do so may cause risk of electrical shock or fire.

5-2 Warranty

We guarantee this product against defects in materials and workmanship for a period of 24 months from the date of purchase. In case you need to repair or replace any defective power inverters, please contact COTEK local distributor.

This warranty will be considered void if the unit has been misused, altered, or accidentally damaged. COTEK is not liable for anything

c @æc Á [& & ~ | • Á æ• Á æÁ ! ^ • ~ | c Á [~ Á c @^ Á ~ • ^

COTEK

No.33, Sec. 2, Renhe Rd., Daxi Dist., Taoyuan City 33548, Taiwan

Phone +8863-3891999 FAX +8863-3802333

[http //www.cotek.com.tw](http://www.cotek.com.tw)

2017.09_A2